

# USERGUIDE

## Wolverine DDW-225-EX

Industrial Ethernet  
SHDSL extender

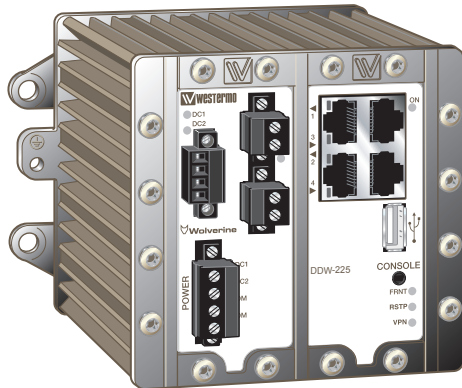



## General information

### Legal information

The contents of this document are provided “as is”. Except as required by applicable law, no warranties of any kind, either express or implied, including, but not limited to, the implied warranties of merchantability and fitness for a particular purpose, are made in relation to the accuracy and reliability or contents of this document. Westermo reserves the right to revise this document or withdraw it at any time without prior notice.

Under no circumstances shall Westermo be responsible for any loss of data or income or any special, incidental, and consequential or indirect damages howsoever caused.

More information about Westermo can be found at the following Internet address:  
[www.westermo.com](http://www.westermo.com)

### Software tools

Related software tools are available in the folder software tools under technical support on the Westermo website.

### License and copyright for included Free/Libre Open Source Software

This product includes software developed by third parties, including Free/Libre Open Source Software (FLOSS). The specific license terms and copyright associated with the software are included in each software package respectively. Please visit the product web page for more information.

Upon request, the applicable source code will be provided. A nominal fee may be charged to cover shipping and media. Please direct any source code request to your normal sales or support channel.

### WeOS Management Guide

This product runs WeOS (Westermo Operation System). Instructions for quick start, configuration, factory reset and use of USB port are found in the WeOS Management Guide at [www.westermo.com](http://www.westermo.com).

## Safety



### **Before installation:**

Read this manual completely and gather all information on the unit. Make sure that you understand it fully. Check that your application does not exceed the safe operating specifications for this unit.

This unit should only be installed by qualified personnel.

This unit should be built-in to an apparatus cabinet, or similar, where access is restricted to service personnel only.

The power supply wiring must be sufficiently fused, and if necessary it must be possible to disconnect manually from the power supply. Ensure compliance to national installation regulations.

This unit uses convection cooling. To avoid obstructing the airflow around the unit, follow the spacing recommendations (see Cooling section).

"Note that this unit can be connected to two different power sources."



### **Before mounting, using or removing this unit:**

Prevent access to hazardous voltage by disconnecting the unit from power supply.

**Warning!** Do not open connected unit. Hazardous voltage may occur within this unit when connected to power supply.

When this unit is operated at an ambient temperature above +60°C (+140°F), the External Surface of Equipment may exceed Touch Temperature Limit according to EN/IEC/UL 60950-1. To reduce the risk of fire, use only No. 26 AWG or larger telecommunication line cord.

## Care recommendations

Follow the care recommendations below to maintain full operation of unit and to fulfil the warranty obligations.

This unit must not be operating with removed covers or lids.

Do not attempt to disassemble the unit. There are no user serviceable parts inside.

Do not drop, knock or shake the unit, rough handling above the specification may cause damage to internal circuit boards.

Do not use harsh chemicals, cleaning solvents or strong detergents to clean the unit.

Do not paint the unit. Paint can clog the unit and prevent proper operation.

Do not expose the unit to any kind of liquids (rain, beverages, etc). The unit is not waterproof. Keep the unit within the specified humidity levels.

Do not use or store the unit in dusty, dirty areas, connectors as well as other mechanical part may be damaged.

If the unit is not working properly, contact the place of purchase, nearest Westermo distributor office or Westermo Tech support.

A readily accessible disconnect device shall be incorporated external to the equipment.

This unit may have hot surfaces when used in high ambient temperature.

## Maintenance

No maintenance is required, as long as the unit is used as intended within the specified conditions.

## Product disposal



This symbol means that the product shall not be treated as unsorted municipal waste when disposing of it. It needs to be handed over to an applicable collection point for recycling electrical and electronic equipment.

By ensuring this product is disposed of correctly, you will help to reduce hazardous substances and prevent potential negative consequences to both environment and human health, which could be caused by inappropriate disposal.



### **ATEX certification number**

Baseefa 14ATEX 0151X

### **Standards**

EN 60079-0:2012, EN 60079-15:2010

### **Certification code**

Ex nA IIC T4 Gc ( $-40^{\circ}\text{C} \leq T_a \leq +70^{\circ}\text{C}$ )

### **ATEX code**

 II 3G

### **Specific Conditions of Use**

The equipment must be installed in an area of not more than pollution degree 2 in accordance with IEC/EN 60664-1, and in an enclosure that provides a minimum degree of protection of at least IP54 and complies with the relevant requirements of EN 60079-0 and EN 60079-15.

All external connections to the equipment must not be inserted or removed unless either the area in which the equipment is installed is known to be non-hazardous, or the circuits connected have been de-energized.

The network cables once installed must be properly fixated by the use of cable ties or similar to reduce the risk of accidentally withdrawing the plugs.

### **Equipment input parameters**

Power Connector: +DC1, +DC2 and –COM

Working Voltage Range = 24 V to 48 VDC.

I/O Connector: Status +, Status –, Digital in + and Digital in –

Maximum I/P Voltage = 60 VDC.



## **ATEX-Zulassungsnummer**

Baseefa 14ATEX 0151X

## **Standards**

EN 60079-0:2012, EN 60079-15:2010

## **Zertifizierungscode**

Ex nA IIC T4 Gc ( $-40^{\circ}\text{C} \leq T_a \leq +70^{\circ}\text{C}$ )

## **ATEX-Code**

 II 3G

## **Spezifische Einsatzbedingungen**

Die Geräte müssen in einem Bereich welcher einem maximalen Verschmutzungsgrad der Stufe 2 gemäß IEC/EN 60664-1 entspricht und in einem Gehäuse, das einen Schutzgrad von mindestens IP54 bietet und die relevanten Anforderungen von N 60079-0 und EN 60079-15 erfüllt, installiert werden.

Alle Anschlüsse des Gerätes dürfen nur dann angeschlossen oder abgeschlossen werden, wenn der Bereich, in dem das Gerät installiert ist, nachweislich ungefährlich oder das Gerät völlig spannungsfrei ist.

Die Netzkabel müssen nach der Installation mithilfe von Kabelbindern oder ähnlichem Material ordnungsgemäß befestigt werden, um ein versehentliches Abziehen der Stecker zu verhindern.

## **Eingangsparameter der Geräte**

Stromversorgung: +DC1, +DC2 und –COM

Betriebsspannungsbereich = 24 V to 48 VDC.

I/O-Anschluss: Status +, Status –, Digital in + und Digital in –

Maximale I/P-Spannung = 60 VDC.

**Numéro de certification ATEX**

Baseefa 14ATEX 0151X

**Normes**

EN 60079-0:2012, EN 60079-15:2010,

**Code de certification**

Ex nA IIC T4 Gc ( $-40^{\circ}\text{C} \leq T_a \leq +70^{\circ}\text{C}$ )

**Code ATEX**

 II 3G

**Conditions spéciales d'utilisation**

L'équipement doit être installé dans une zone où le degré de pollution ne dépasse pas le degré 2 conformément à l'IEC/EN 60664-1, et dans un boîtier qui fournit un niveau de protection au moins égal à IP54 et conforme aux exigences applicables à EN 60079-0 et EN 60079-15

Toutes les connexions externes à l'équipement ne doivent pas être insérés ou retirés sauf si la zone dans laquelle l'équipement est installé est reconnue comme non dangereuse, ou si les circuits raccordés sont hors-tension.

Une fois les câbles réseau installés, ils doivent être correctement fixé grâce à des attaches de câbles ou autre élément semblable afin de réduire le risque de débranchement accidentel.

**Paramètres d'entrée des équipements**

Connecteur d'alimentation : +DC1, +DC2 et –COM

Double entrée d'alimentation 24 V à 48 VCC

Connecteur E/S : Statut +, Statut –, Entrée digitale + et Entrée digitale –

Tension maximale I/P = 60 VCC.



### General

This unit is intended to be used in Zone 2 hazardous location only.

### Marking

 II 3G

Ex nA IIC T4 Gc

SPECIAL CONDITION

WARNING – DO NOT SEPARATE WHEN ENERGIZED

	Indicate that this unit complies with relevant European standards that are harmonised with the 2014/34/EU Directive (ATEX).
<b>II</b>	Equipment group II. This unit can be installed in all places with an explosive gas atmosphere other than mines susceptible to firedamp.
<b>3</b>	Equipment category 3. A category is the classification according to the required level of protection. This unit ensures the requisite level of protection during normal operation and is intended for use in areas in which explosive atmosphere caused by gases, vapours, mists, or dust mixtures are unlikely to occur or, if they do occur, are likely to do so only infrequently and for a short period only.
<b>G</b>	Indicates protection concerning explosive atmospheres caused by gases, vapours or mists (G).
<b>Ex</b>	Indicates that this unit is in conformity with relevant European Ex standard(s).
<b>nA</b>	The type of protection used. This unit is a non-sparking device "nA" which is constructed to minimize the risk of occurrence of arcs or sparks capable of creating an ignition hazard during conditions of normal operation.
<b>IIC</b>	Gas group, a typical gas is hydrogen.
<b>T4</b>	Temperature class T4 (T4 = 135°C). This unit is classified in accordance with its maximum surface temperature (external and internal).
<b>Gc</b>	Equipment protection level Gc (EPL Gc) Equipment for explosive gas atmospheres, having a "enhanced" level of protection, which is not a source of ignition in normal operation and which may have some additional protection to ensure that it remains inactive as an ignition source in the case of regular expected occurrences. EPL Gc are analogous to the ATEX Categories (Category 3 G = EPL Gc).
<b>SPECIAL CONDITION</b>	This unit has a special condition for safe use. The special condition for safe use contains safety related information that is necessary for the correct installation and safe use.

## Special condition for use

### *Ambient temperature:*

This unit is designed for use in extreme ambient temperature conditions according to the following:  $-40\text{ °C} \leq T_{\text{amb}} \leq +70\text{ °C}$

### *Installation in an apparatus cabinet:*

This unit requires installation in an Ex certified apparatus cabinet suitable for the area of use and providing a degree of protection of at least IP54.

### *Resistance to impact:*

This unit requires installation in an apparatus cabinet where adequate resistance to impact is provided by the apparatus cabinet. See "Installation in an apparatus cabinet" above for requirements on the external apparatus cabinet.

### *Secureness of plugs:*

When this unit is installed in an explosive atmospheres, all connectors must be mechanically secured to prevent loosening.

### *Conductor temperature:*

When this unit is installed in locations with high ambient temperature, special precautions shall be taken upon the choice of external conductor(s) and the temperature rating of the conductor(s).

### *Directive 2014/34/EU alongside with other directives:*

Directive 2014/30/EU (EMC) applies and to assure a safe performance of this unit under the scope of Directive 2014/34/EU, refer to the electromagnetic immunity level specified under "Type tests and environmental conditions" in this manual.

### *Warning marking:*

When this unit is installed in an explosive atmospheres, the warning label submitted together with this unit shall be attached on the unit and visible to the end user.

## Standards and date of compliance

**EN 60079-0 and EN 60079-15**  
**2014-06-19**

## Ratings

<b>Power</b>	(20 – 48) VDC; 330 mA
<b>Ambient temperature</b>	-40°C ≤ Ta ≤ +70°C
<b>Ingress protection (IP)</b>	IP40
<b>Maximum surface temperature</b>	135°C (temperatur class T4)

## Safety Control Drawing

<b>Degree of protection</b>	IP40
<b>Ambient temperature</b>	-40°C to +70°C
<b>Installation spacing</b>	Minimum 25 mm above / below Minimum 10 mm left / right

Direction relative this unit!

Position	Direction*/description	Input/Output values
1	IO / Status +	$U_{in} = 60 \text{ VDC max}$ $I_{in} = 80 \text{ mA max}$
2	IO / Status -	
3	IO / Digital in +	$U_{in} = 60 \text{ VDC max}$ $I_{in} = 10 \text{ mA max}$
4	IO / Digital in -	

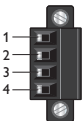

Position	Direction*/description	Input/Output values
1	In/Out / SHDSL	$U = \pm 15 \text{ Vpk}$ $I = \pm 25 \text{ mA}$ Data rate up to 15.3 Mbit/s
2	In/Out / SHDSL	

\* Galvanically isolated via signal transformer and capacitively isolated to signal ground through a 1.5 kV 220 pF capacitor. See user manual for proven transient protection.

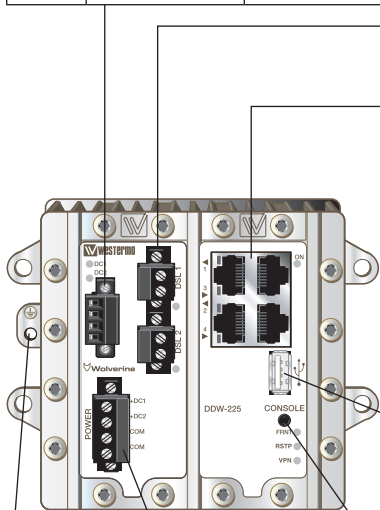

M5 threaded hole for PE connection.

Position	Direction*/description	Input/Output values
1	In/Out / TD+	$U = \pm 1 \text{ V} (4\mu\text{V/s})$ $I = \pm 20 \text{ mA}$ Data rate: 10/100 Mbit/s
2	In/Out / TD-	
3	In/Out / RD+	
4	Not connected	
5	Not connected	
6	In/Out / RD-	
7	Not connected	
8	Not connected	
Shield	PE	

\* Galvanically isolated via signal transformers and capacitively isolated to signal ground through a 2 kV 1000 pF capacitor. See user manual for proven transient protection.

Position	Direction/description	Input values
1	Out / VBUS	$U_{out} = 5 \text{ VDC max}$ $I_{out} = 500 \text{ mA max}$
2	In/out / D-	
3	In/out / D+	
4	GND	
Shield	PE	

Position	Direction*/description	Input values
1	In / +Voltage A	$U_{in} = (16 - 60) \text{ VDC}$ $I_{in} = 420 \text{ mA @ } 16 \text{ VDC}$ $P_{in} = \text{Max } 7 \text{ W}$
2	In / +Voltage B	
3	In / Common	
4	In / Common	

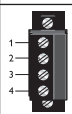

Position	Direction/description	Input/Output values
1	In/out / GND	$U = 3.3 \text{ VDC max}$ $I = 24 \text{ mA max}$
2	Out / Tx	
3	In / Rx	

\* See section *Type tests and environmental conditions* in this user manual for proven transient protection.

## Agency approvals and standards compliance

Type	Approval / Compliance
EMC	EN 61000-6-1, Immunity residential environments
	EN 61000-6-2, Immunity industrial environments
	EN 61000-6-3, Emission residential, commercial and light-industrial environments
	EN 61000-6-4, Emission industrial environments
	EN 50121-4, Railway signalling and telecommunications apparatus
Safety	UL/IEC/EN 60950-1, IT equipment
SHDSL	ITU-T G.991.2
EX	EN 60079-0 and EN 60079-15

### FCC Part 15.105 Notice:

This equipment has been tested and found to comply with the limits for a Class B digital device, pursuant to Part 15 of the FCC Rules. These limits are designed to provide reasonable protection against harmful interference in a residential installation. This equipment generates, uses and can radiate radio frequency energy and, if not installed and used in accordance with the instructions, may cause harmful interference to radio communications. However, there is no guarantee that interference will not occur in a particular installation. If this equipment does cause harmful interference to radio or television reception, which can be determined by turning the equipment off and on, the user is encouraged to try to correct the interference by one or more of the following measures:

- ⌘ Reorient or relocate the receiving antenna
- ⌘ Increase the separation between the equipment and receiver
- ⌘ Connect the equipment into an outlet on a circuit different from that to which the receiver is connected
- ⌘ Consult the dealer or an experienced radio/TV technician for help.

# Declaration of Conformity



Westermo Teleindustri AB

## Declaration of Conformity

The manufacturer Westermo Teleindustri AB  
SE-640 40 Stora Sundby, Sweden

Herewith declares that the product(s)

Type of product	Models	Art no
Industrial Ethernet SHDSL extender	Wolverine DDW-225	3642-0250
	Wolverine DDW-225 EX	3642-5250
	Wolverine DDW-226	3642-0240
	Wolverine DDW-226 EX	3642-5240

is in conformity with the following EU directive(s).

No	Short name
2014/30/EU	Electromagnetic Compatibility (EMC)
2014/35/EU	Low Voltage Directive (LVD)
2014/34/EU <sup>1</sup>	Equipment Explosive Atmospheres (ATEX)
2011/65/EU	Restriction of the use of certain hazardous substances in electrical and electronic equipment (RoHS)

References of standards applied for this EU declaration of conformity.

No	Title	Issue
EN 61000-6-1	Electromagnetic compatibility – Immunity for residential environments	2007
EN 61000-6-2	Electromagnetic compatibility – Immunity for industrial environments	2005
EN 61000-6-3	Electromagnetic compatibility – Emission residential environments	2007
EN 61000-6-4	Electromagnetic compatibility – Emission for industrial environments	2007
EN 50121-4	Railway applications – Electromagnetic compatibility – Emission and immunity of the signalling and telecommunications apparatus	2015
EN 60950-1	Information technology equipment -- Safety -- General requirements	2006 +A11: 2009
EN 60079-0 <sup>1</sup>	Explosive atmospheres Equipment – General requirements	2012
EN 60079-15 <sup>1</sup>	Electrical apparatus for explosive gas atmospheres –Construction, test and marking of type of protection “n” electrical apparatus	2010
EN 50581	Technical documentation for the assessment of electrical and electronic products with respect to the restriction of hazardous substances	2012

Signature

Pierre Öberg  
Technical Manager  
9<sup>th</sup> March 2017

<sup>1</sup> Only applicable for article no. 3642-5240, 3642-5250. Certificate: Baseefa14ATEX0151X. Issued by: SGS Baseefa Limited, Rockhead Business Park, Staden Lane, Buxton, Derbyshire, SK17 9RZ, United Kingdom.

Postadress/Postal address  
S-640 40 Stora Sundby  
Sweden

Tel.  
016-428000  
Int+46 16428000

Telefax  
016-428001  
Int+46 16428001

Postgiro  
52 72 79-4

Bankgiro  
5671-5550

Org.nr/  
Corp. identity number  
556361-2604

Registered office  
Eskilstuna

## Type tests and environmental conditions

Phenomena	Test	Description	Test levels
ESD	EN 61000-4-2	Enclosure contact	± 6 kV
		Enclosure air	± 8 kV
RF field AM modulated	IEC 61000-4-3	Enclosure	20 V/m 80% AM (1 kHz), 80 – 2700 MHz 10 V/m 80% AM (1 kHz), 2700 – 6000 MHz
Fast transient	EN 61000-4-4	Signal ports	± 2 kV
		Power ports	± 2 kV
Surge	EN 61000-4-5	Signal ports unbalanced	± 2 kV line to earth, ± 2 kV line to line
		Signal ports balanced	± 2 kV line to earth, ± 1 kV line to line
		Power ports	± 2 kV line to earth, ± 1 kV line to line
RF conducted	EN 61000-4-6	Signal ports	10 V 80% AM (1 kHz), 0.15 – 80 MHz
		Power ports	10 V 80% AM (1 kHz), 0.15 – 80 MHz
Power frequency magnetic field	EN 61000-4-8	Enclosure	300 A/m
Pulse magnetic field	EN 61000-4-9	Enclosure	300 A/m
Mains freq. 50 Hz	EN 61000-4-16	Signal ports	100 V 50 Hz line to earth
Mains freq. 50 Hz	SS 436 15 03	Signal ports	250 V 50 Hz line to line
Voltage dips and interruption	EN 61000-4-29	DC power ports	10 ms, interruption 10 ms, 30% reduction 10 ms, 60% reduction +20% above & -20% below rated voltage
Radiated emission	CISPR 16-2-3 ANSI C63.4 (FCC part 15)	Enclosure	Class A and Class B, 30 – 6000 MHz
		Enclosure	Class A and Class B, 30 – 6500 MHz
Conducted emission	CISPR 16-2-1	DC power ports	Class A and Class B
Dielectric strength	EN 60950	Signal port to other isolated ports	1500 Vrms 50 Hz 1 min
		Power port to other isolated ports	1500 Vrms 50 Hz 1 min
Temperature	EN 60068-2-1 EN 60068-2-2	Operating	-40 to +70°C
		Storage & Transport	-40 to +85°C
		Maximum surface temperature	135°C (temperature class T4)
Humidity	EN 60068-2-30	Operating	5 to 95% relative humidity
		Storage & Transport	5 to 95% relative humidity
Altitude		Operating	2 000 m / 70 kPa
Reliability prediction (MTBF)	MIL-HDBK-217F	Operating	410 000 hours @ 25°C
Service life		Operating	10 year
Vibration	IEC 60068-2-6	Operating	7.5 mm, 5 – 8 Hz
			2 g, 8 – 500 Hz
Shock	IEC 60068-2-27	Operating	15 g, 11 ms
Enclosure	UL 94	Aluminium/Zink	Flammability class V-0
Dimension W x H x D			134 x 105 x 122 mm
Weight			1.5 kg
Degree of protection	IEC 60529	Enclosure	IP40

## Description

DDW-225 is a part of the Wolverine family of Ethernet extenders. It uses the Westermo WeOS operating system that provides the DDW-225 with all the advanced switching and routing functionality supported by the DDW-225. These functions include VLAN support, Layer 2/3 switching, Static Routing, Firewall functions, IGMP Snooping, VPN support.

A further enhancement the DDW-225 provides is a set of advanced diagnostic functions that allow the SHDSL line to be dynamically monitored allowing alarms to be configured to pre-warn of any performance issues. This monitoring data can be accessed in a number of ways; it can be read at any time through the Web Interface, Command Line Interface or via SNMP.

A key function of the DDW-225 is its ability to be used to create redundant ring networks over the SHDSL links, using both the Westermo FRNT protocol, but also RSTP.

- ⌘ Up to 15.3 Mbit/s over old cables
- ⌘ Redundant ring on the SHDSL interface
- ⌘ Advanced Diagnostics
- ⌘ VLAN support and IGMP Snooping
- ⌘ VPN support

## Interface specifications

<b>Power</b>	
Rated voltage	20 to 48 VDC
Operating voltage	16 to 60 VDC
Rated current	330 mA (495 mA) @ 20 VDC (with 500 mA USB load) 150 mA (215 mA) @ 48 VDC (with 500 mA USB load)
Rated frequency	DC
Inrush current, I <sup>2</sup> t	1.5 A <sup>2</sup> s
Startup current*	400 mA
Polarity	Reverse polarity protected
Redundant power input	Yes
Isolation to	All other
Connection	Detachable screw terminal
Connector size	0.2 – 2.5 mm <sup>2</sup> (AWG 24 – 12)
Shielded cable	Not required

\* External supply current capability for proper startup.

<b>Console</b>	
Electrical specification	TTL-level
Data rate	115.2 kbit/s
Data format	8 data bits, none parity, 1 stop bit, no flow control
Circuit type	SELV
Isolation to	All other except USB
Galvanic connection to	USB
Connection	2.5 mm jack, use Westermo cable 1211-2027



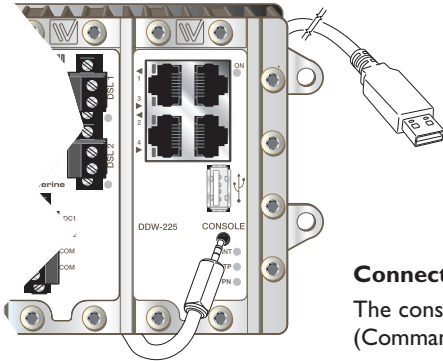

### Connection to console port

The console port can be used to connect to the CLI (Command Line Interface).

#### The following steps needs to be taken

1. Connect the serial diagnostic cable to the console port (use only Westermo cable 1211-2027).
2. Connect cable to your computer (USB port, if drivers are needed they can be downloaded from our Web page).
3. Use a terminal emulator and connect with correct speed and format to the assigned port.

For more information about the CLI, see the WeOS management guide.

USB	
Electrical specification	USB 2.0 host interface
Data rate	Up to 12 Mbit/s (full-speed mode)
Circuit type	SELV
Maximum supply current	500 mA
Isolation to	All other except Console
Galvanic connection to	Console
Connection	USB receptacle connector type A
Conductive housing	Yes

I/O / Relay output	
Connect resistance	30 Ω
Isolation to	All other
Connection	Detachable screw terminal
Connector size	0.2 – 2.5 mm <sup>2</sup> (AWG 24 – 12)
Maximum voltage/current	60 VDC / 80 mA
I/O / Digital input	
Voltage levels	Logic one >12V, Logic zero <1V
Isolation to	All other
Connection	Detachable screw terminal
Connector size	0.2 – 2.5 mm <sup>2</sup> (AWG 24 – 12)

<b>Ethernet TX</b>	
Electrical specification	IEEE std 802.3. 2005 Edition
Data rate	10 Mbit/s or 100 Mbit/s, manual or auto
Duplex	Full or half, manual or auto
Circuit type	TNV-1
Transmission range	Up to 150 m with CAT5e cable or better
Isolation to	All other
Connection	RJ-45 auto MDI/MDI-X
Shielded cable	Not required, except when installed in Railway applications as signalling and telecommunications apparatus and located close to rails.*
Conductive housing	Yes
Number of ports	4

\* To minimise the risk of interference, a shielded cable is recommended when the cable is located inside 3 m boundary or the cable is longer than 30 m and inside 10 m boundary to the rails and connected to this port.

<b>SHDSL</b>	
Electrical specification	ITU-T G.991.2 Annex B
Data rate	32 kbit/s to 15.3 Mbit/s
Protocol	EFM according to IEEE 802.3-2005
Transmission range	According to ITU-T G.991.2 depending on line quality
Isolation to	All other
Connection	Detachable screw terminal
Connector size	0.2 – 2.5 mm <sup>2</sup> (AWG 24 – 12)
Shielded cable	Not required
Number of ports	2

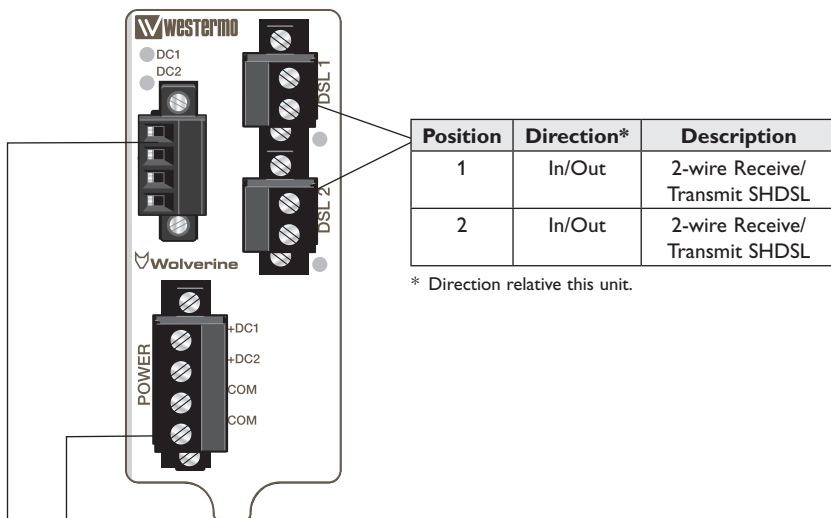

\* Direction relative this unit.

Position	Direction*	Description	Product marking
1	In	+ Voltage A	+DC1
2	In	+ Voltage B	+DC2
3	In	Common	COM
4	In	Common	COM

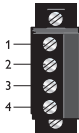

\* Direction relative this unit.

Position	Direction*	Description
1	Out	Status +
2	Out	Status -
3	In	Digital in +
4	In	Digital in -

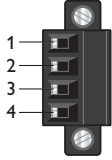

\* Direction relative this unit.

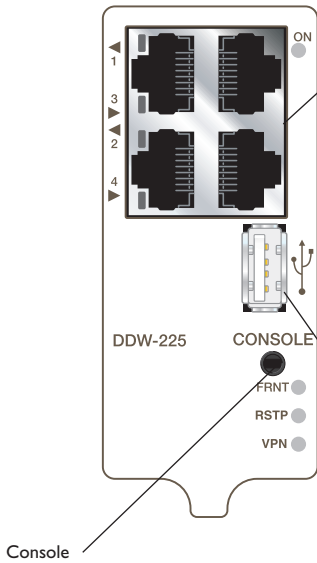

Position	Direction*	Description
1	In/Out	TD+
2	In/Out	TD-
3	In/Out	RD+
4	-	Not connected
5	-	Not connected
6	In/Out	RD-
7	-	Not connected
8	-	Not connected
Shield	In/Out	Connected to PE

\* Direction relative this unit.

Position	Direction*	Description
1	Out	VBUS
2	In/Out	D-
3	In/Out	D+
4	Out	GND
Shield	In/Out	Connected to PE

\* Direction relative this unit.

# LED indicators

LED	Status	Description
ON	OFF	Unit has no power.
	GREEN	All OK, no alarm condition.
	RED	Alarm condition, or until unit has started up. (Alarm conditions are configurable, see "WeOS Management Guide").
	BLINK	Location indicator ("Here I am!"). Activated when connected to IPConfig Tool, or upon request from Web or CLI.
DC1	OFF	Unit has no power.
	GREEN	Power OK on DC1.
	RED	Power failure on +DC1.
DC2	OFF	Unit has no power.
	GREEN	Power OK on DC2.
	RED	Power failure on +DC2.
FRNT	OFF	FRNT disabled.
	GREEN	FRNT OK.
	RED	FRNT Error.
	BLINK	Unit configured as FRNT Focal Point.
RSTP	OFF	RSTP disabled.
	GREEN	RSTP enabled.
	BLINK	Unit elected as RSTP/STP root switch.
VPN	OFF	VPN disabled.
	GREEN	(Configurable) Default: At least one VPN tunnel up and OK.
	RED	(Configurable) Default: All VPN tunnels down.
Copper ports Port 1-4	OFF	No Link.
	GREEN	Link established.
	GREEN FLASH	Data traffic indication.
	YELLOW	Port alarm and no link. Or if FRNT or RSTP mode, port is blocked.
DSL ports Port 1-2	OFF	No SHDSL link.
	GREEN	SHDSL link established.
	GREEN BLINK	SHDSL link negotiation.
	GREEN FLASH	Data traffic indication.
	YELLOW	Port alarm and no link. Or if FRNT or RSTP mode, port is blocked.
	YELLOW BLINK	Only during unit startup. Firmware downloading to SHDSL chip.

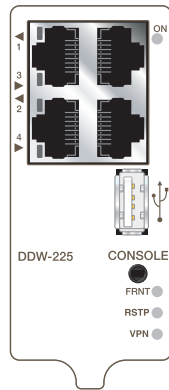
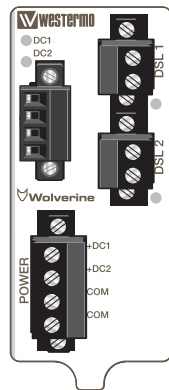

## Mounting

### Mounting, 35 mm DIN-rail

The unit can be mounted on a 35 mm DIN-rail, which is horizontally mounted inside an apparatus cabinet, or similar. Snap on mounting, see figure.

**Note!** For proper vibration and chock performance Westermo recommends standard top-hat DIN-rail TH 35-15 according to EN 60715.

### Removal

Press down the support at the back of the unit using a screwdriver. See figure.

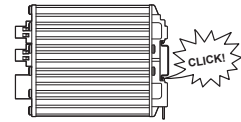
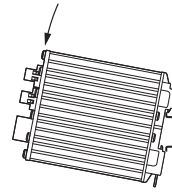
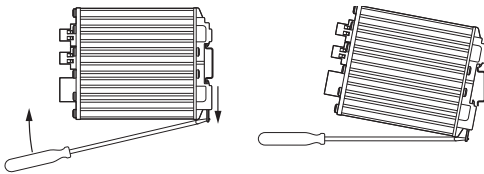

### Wall mounting

This unit can also be wall-mounted, see figure.

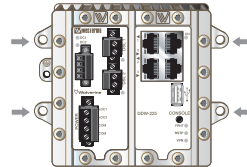

### Earth connection

For correct function the ground connection on the unit needs to be properly connected to a solid ground. See figure.

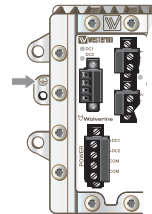

### Cooling

This unit uses convection cooling. To avoid obstructing the airflow around the unit, use the following spacing rules. Minimum spacing 25 mm (1.0 inch) above/below and 10 mm (0.4 inches) left/right the unit.

Spacing is recommended for the use of unit in full operating temperature range and service life. See figure.

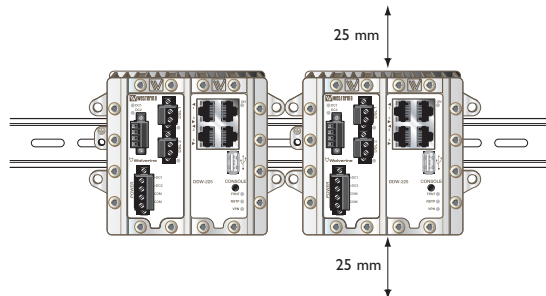

## Getting Started

This product runs Westermo Operating System (WeOS) which provides several management tools that can be used for configuration of the unit.

- **IPConfig tool**  
This is a custom Westermo tool used for discovery of attached Westermo units.
- **Web**  
Configuration of the unit using the web browser.
- **CLI**  
Configuration of the unit via the Command Line Interface.

If the computer is located in the same subnet as the switch you can easily use a web browser to configure the unit. Within the web you can configure most of the available functions.

For advanced network settings and more diagnostic information, please use the CLI. Detailed documentation is available in the chapter "The Command Line Management Tool" in the WeOS management guide.

Factory default	<i>IP address:</i>	192.168.2.200
	<i>Netmask:</i>	255.255.255.0
	<i>Gateway:</i>	Disabled

**Note!** If you are not sure about the subnet – consult your network administrator.

## Configuration

### Configure the unit via web browser

The unit can easily be configured via a Web browser.

Open the link <http://192.168.2.200> in your web browser, and you will be prompted with a Login screen, where the default settings for Username and Password are:

*Username:* admin

*Password:* westermo

Once you have logged in, you can use the extensive integrated help function describing all configuration options. Two common task when configuring a new switch is to assign appropriate IP settings, and to change the password of the admin account.

The password can be up to 64 characters long, and should consist of printable ASCII characters (ASCII 33-126); 'Space' is not a valid password character.

**Note!** Version of IP Config tool must be 10.3.0 or higher.

## Referring documents

Type	Description	Document number
Management Guide	Westermo OS management guide	6101-3201

### Factory default on DDW-225

It is possible to set the unit to factory default settings by using two standard Ethernet RJ-45 cables.

1. Power off the switch and disconnect all Ethernet cables and DSL cables.
  2. Connect one Ethernet cable between Ethernet port 1 and Ethernet port 4, and another Ethernet cable between Ethernet port 2 and Ethernet port 3.  
The ports need to be connected directly by Ethernet cables, i.e., not via a hub or switch. Use straight cables – not cross-over cables – when connecting the port pairs.
  3. Power on the unit.
  4. Wait for the unit to start up. Control that the ON LED is flashing red.  
The ON LED flashing indicates that the unit is now ready to be reset to factory default. You now have the choice to go ahead with the factory reset, or to skip factory reset and boot as normal.
    - Go ahead with factory reset:  
Acknowledge that you wish to conduct the factory reset by unplugging one of the Ethernet cables. The ON LED will stop flashing.  
This initiates the factory reset process\*, and after approximately 1 minute the unit will restart with factory default settings. When the switch has booted up, the ON LED will typically show a green light (a red light is shown if only one of the DC power feeds is connected).
    - Skip the factory reset:  
To skip the factory reset process, just wait for approximately 30 seconds (after the ON LED starts flashing RED) without unplugging any of the Ethernet cables. The switch will conduct a normal boot with the existing settings.
- \* **Note** Do not power off the unit while the factory reset process is in progress.











Westermo • SE-640 40 Stora Sundby, Sweden  
Tel +46 16 42 80 00 Fax +46 16 42 80 01  
E-mail: [info@westermo.com](mailto:info@westermo.com)  
[www.westermo.com](http://www.westermo.com)